

Series Tee

Mega Industries WR1500 waveguide tees are manufactured to exacting electrical and mechanical specifications. We offer a range of styles and configurations, which includes E-Plane and H-Plane folded magic tees, shunt tees, series tees and magic tees. Our manufacturing process provides maximum symmetry in fabrication.

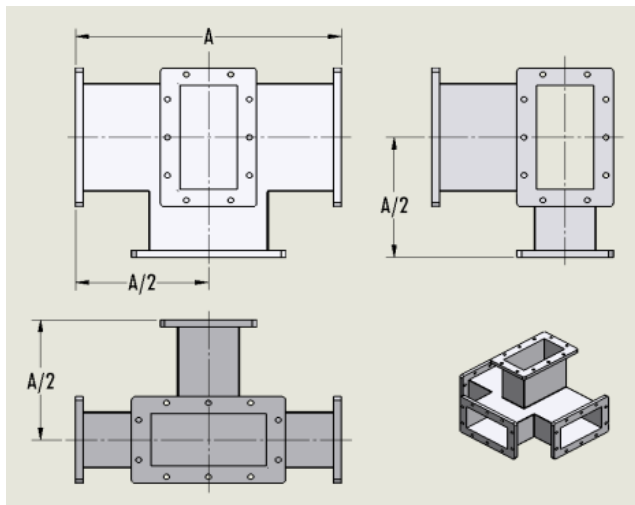

Magic Tee

Colinear Balance	+/- 0.1 dB
Insertion Loss	Less than 0.1 dB
E-H Isolation	30 dB minimum
VSWR	1.10:1
Length of A	30.00 inches



Folded Magic Tee



Shunt Tee

Mega Industries, LLC • 28 Sanford Drive, Gorham, ME 04038 USA

Phone: 207-854-1700 • Email: sales@megaind.com

Website: www.megaind.com • ISO 9001:2015 & AS9100D