

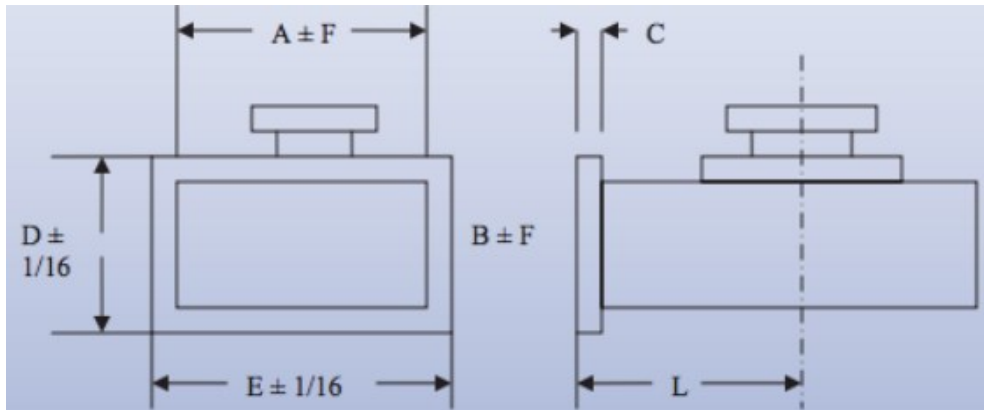

Mega Industries WR1800 Transitions to Coaxial are manufactured to precise tolerances. For laboratory testing or other low power applications, we recommend “Probe type” transitions to type “N” coaxial line; while our low VSWR “cross-bar” design provides optimum electrical performance for high power applications.



A	18.00 inches
B	9.00 inches
C	0.62 inches
D	12.50 inches
E	21.50 inches
F	0.20 inches
L	12 inches
Wall Thickness	0.190 inches
Max Pressure	0.25 PSIG