

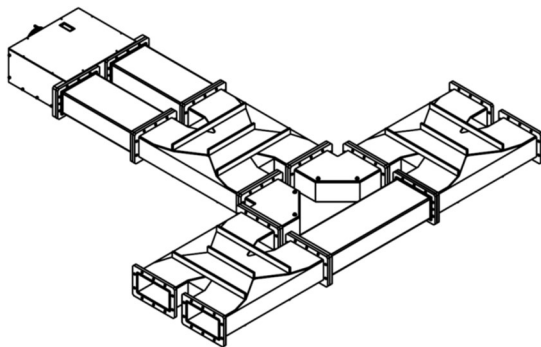

Mega Industries manufactures WR284 attenuators in fixed and variable precision. Low to medium power devices utilize high density shaped microwave absorbing elements, which are permanently attached to a standard waveguide section. For extremely high power and low loss applications, Mega offers hybrid-style variable attenuators. These exhibit a minimum insertion loss of 0.05 dB. However, they can be varied to 30 dB attenuation under full transmitter power. Both manual and motor driven devices are available to meet the most exacting requirements for your waveguide system.

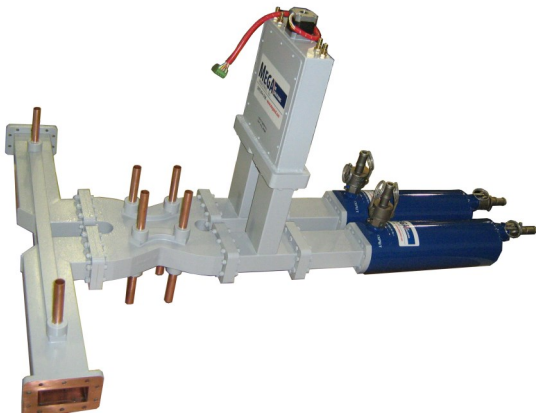

Frequency	2.60 - 3.95 GHz
Construction	Aluminum, OFHC Copper (other by request)
Attenuation	> 35 dB
Frequency Operating Band	+/- 1% @ <1.15:1 VSWR
Frequency Operating Band	+/- 5% @ <1.50:1 VSWR
Pressurized	up to 45psig (3 ATM gauge)
Vacuum	up to 10 ⁹ mbar
Insertion Loss	< 0.1 dB

Mega Industries, LLC • 28 Sanford Drive, Gorham, ME 04038 USA

Phone: 207-854-1700 • Email: sales@megaind.com

Website: www.megaind.com • ISO 9001:2015 & AS9100D