

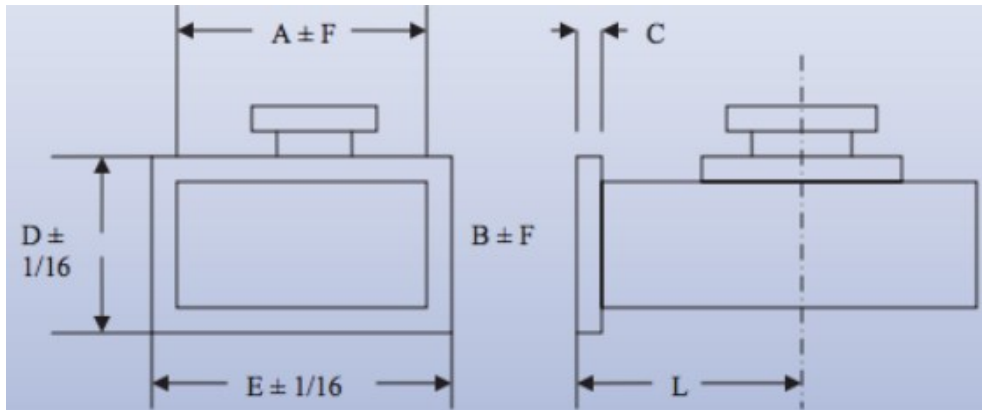

Mega Industries WR430 Transitions to Coaxial are manufactured to precise tolerances. For laboratory testing or other low power applications, we recommend “Probe type” transitions to type “N” coaxial line; while our low VSWR “cross-bar” design provides optimum electrical performance for high power applications.



A	4.30 inches
B	2.15 inches
C	0.038 inches
D	4.19 inches
E	6.34 inches
F	0.005 inches
L	4 inches
Wall Thickness	0.125 inches
Max Pressure	1.5 PSIG