

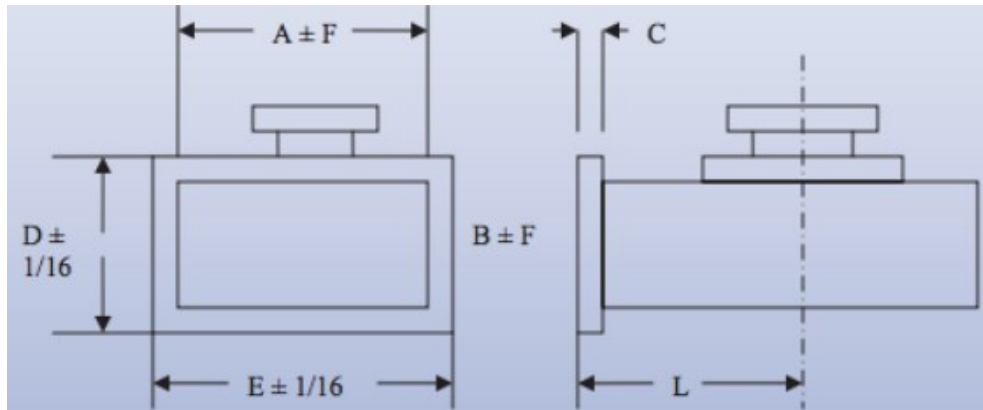

Mega Industries WR975 Transitions to Coaxial are manufactured to precise tolerances. For laboratory testing or other low power applications, we recommend “Probe type” transitions to type “N” coaxial line; while our low VSWR “cross-bar” design provides optimum electrical performance for high power applications.



A	9.75 inches
B	4.875 inches
C	0.44 inches
D	8.38 inches
E	13.25 inches
F	0.10 inches
L	6 inches
Wall Thickness	0.125 inches
Max Pressure	0.50 PSIG